

### Low-cost DIP Switch with Slide Pins

- Allows automatic mounting with DIP IC insertion machines
- Washable models with seal tape are available
- SMT (surface-mounted terminal) models are available with/without embossed tape

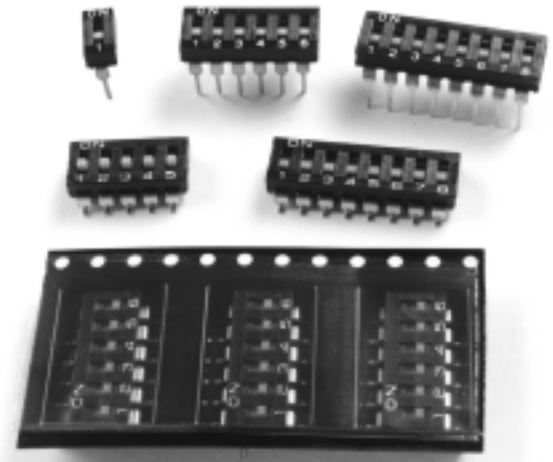

### Ordering Information

No. of poles	Flat actuated		Raised actuator	Flat actuated			Raised actuator
	Standard	With seal tape		Standard	Tape seal	Tape seal in embossed tape	
	DIP terminal	DIP terminal	DIP terminal	SMT terminal	SMT terminal	SMT terminal	SMT terminal
1	A6T-1101	A6T-1102	A6T-1104	---	---	---	---
2	A6T-2101	A6T-2102	A6T-2104	A6S-2101	A6S-2102	---	A6S-2104
3	---	---	---	A6S-3101	A6S-3102	---	A6S-3104
4	A6T-4101	A6T-4102	A6T-4104	A6S-4101	A6S-4102	A6S-4102-P	A6S-4104
5	---	---	---	A6S-5101	A6S-5102	---	A6S-5105
6	A6T-6101	A6T-6102	A6T-6104	A6S-6101	A6S-6102	A6S-6102-P	A6S-6104
7	---	---	---	A6S-7101	A6S-7102	---	A6S-7104
8	A6T-8101	A6T-8102	A6T-8104	A6S-8101	A6S-8102	A6S-8102-P	A6S-8104
9	---	---	---	A6S-9101	A6S-9102	---	A6S-9104
10	A6T-0101	A6T-0102	A6T-0104	A6S-0101	A6S-0102	---	A6S-0104

# Specifications

## RATINGS/CHARACTERISTICS

Switching capacity		25 mA at 24 VDC
Insulation resistance		100 MΩ min. (at 250 VDC)
Contact resistance		200 mΩ max. (initial value)
Dielectric strength		500 VAC for 1 min between terminals of same polarity, and between terminals of different polarity
Vibration resistance		Malfunction: 10 to 55 Hz, 1.5-mm double amplitude
Shock resistance		Malfunction: 300 m/s <sup>2</sup> min. (approx. 30G min.)
Life expectancy	Mechanical	1,000 operations min.
	Electrical	1,000 operations min.
Ambient temperature	Operating	-20°C to 70°C (with no icing)
Ambient humidity	Operating	35% to 90%
Operating force		0.29 N min. (30 gf)

## Dimensions

Unit: mm

Note: Unless otherwise specified, a tolerance of ±0.4 mm applies to all dimensions.

### Flat Actuated with DIP Terminal Standard/With Seal Tape

A6T-□101  
A6T-□102

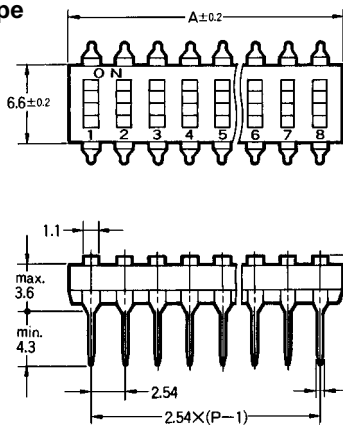
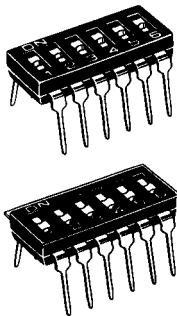

Flat Actuated Standard

With Seal Tape

Raised Actuator

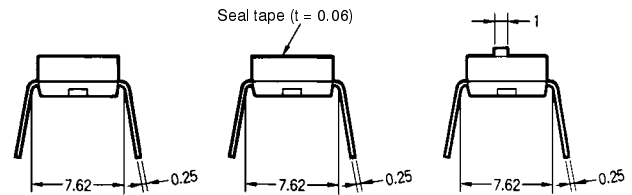

### Raised Actuator with DIP Terminal

A6T-□104

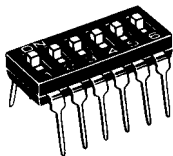

### PCB Dimensions (Top View)

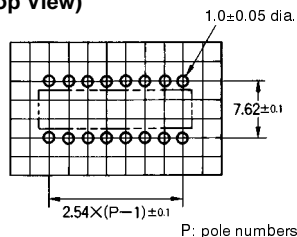

No. of poles	Model			A
	A6T-1101	A6T-1102	A6T-1104	
1	A6T-2101	A6T-2102	A6T-2104	3.48
2	A6T-4101	A6T-4102	A6T-4104	6.02
4	A6T-6101	A6T-6102	A6T-6104	11.10
6	A6T-8101	A6T-8102	A6T-8104	16.18
8	A6T-0101	A6T-0102	A6T-0104	21.26
10				26.34

**Flat Actuated with SMT Terminal  
Standard/With Seal Tape**

A6S-□101  
A6S-□102  
A6S-□102-P

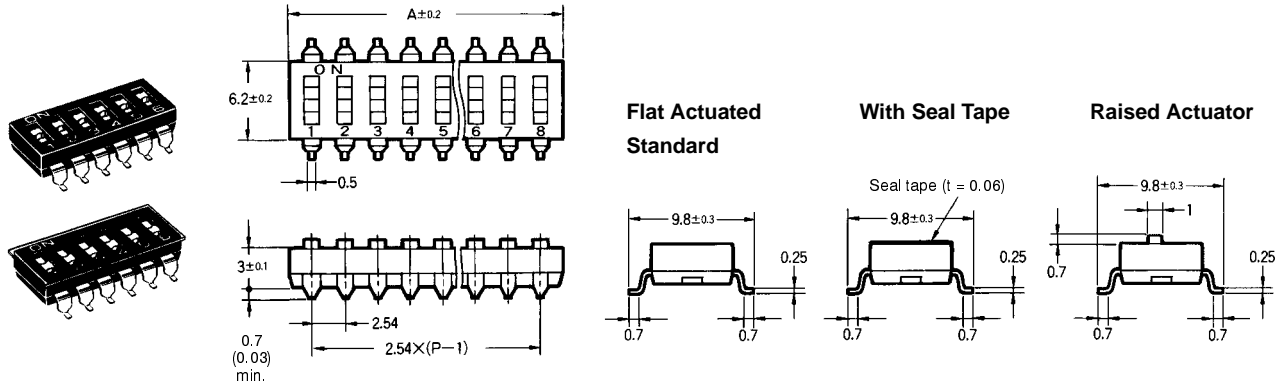

**Embossed Tape  
A6S-□102-P**

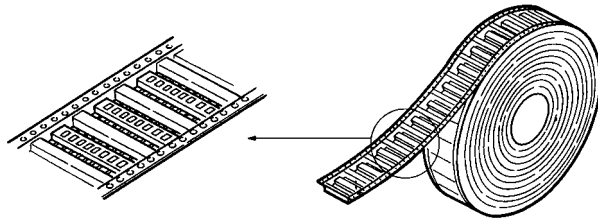

No. of poles	Part number				A
2	A6S-2101	A6S-2102	---	A6S-2104	6.02 (0.24)
3	A6S-3101	A6S-3102	---	A6S-3104	8.56 (0.34)
4	A6S-4101	A6S-4102	A6S-4102-P	A6S-4104	11.10 (0.44)
5	A6S-5101	A6S-5102	---	A6S-5104	13.64 (0.54)
6	A6S-6101	A6S-6102	A6S-6102-P	A6S-6104	16.18 (0.64)
7	A6S-7101	A6S-7102	---	A6S-7104	18.72 (0.74)
8	A6S-8101	A6S-8102	A6S-8102-P	A6S-8104	21.26 (0.84)
9	A6S-9101	A6S-9102	---	A6S-9104	23.80 (0.94)
10	A6S-0101	A6S-0102	---	A6S-0104	26.34 (1.04)

**Raised Actuator  
with SMT Terminal**

A6S-□104

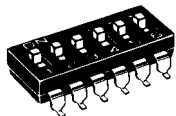

**PCB Dimensions  
(Top View)**

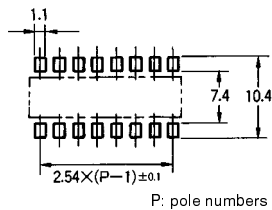

# Installation

## INTERNAL CONNECTIONS (TOP VIEW)

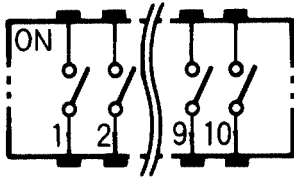

# Precautions

## CIRCUIT DESIGN

Use the DIP Switch within the rated voltage and current ranges, otherwise the DIP Switch may have a shortened life expectancy, radiate heat, or burn out.

## MOUNTING

Do not operate the DIP Switch while mounting, soldering, or washing the DIP Switch, otherwise the DIP Switch may deform due to the heat of the solder, the DIP Switch may malfunction due to the penetration of the washing agent, or the machine incorporating the DIP Switch may operate or be set incorrectly.

An automatic insertion machine incorporating a body stopper is available for mounting the DIP Switch. When using an automatic insertion machine incorporating a half-lead stopper to mount the DIP Switch, make sure that the automatic insertion machine will not deform the terminals of the DIP Switch, otherwise the improper insertion of the DIP Switch may result. Deformation of the terminals of the DIP Switch, otherwise the improper insertion of the DIP Switch may result.

## SOLDERING

Observe the following conditions when soldering the DIP Switch.

### Automatic Soldering Bath

Soldering temperature: 350°C at the tip of the soldering iron.  
Soldering time: 3 s max. for a 1.6-mm thick, single-side PCB.

## Reflow Soldering

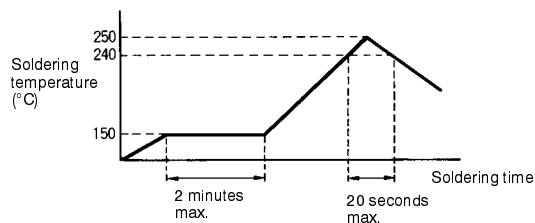

## Manual Soldering

Soldering temperature: 350°C at the tip of the soldering iron.  
Soldering time: 3 s max. for a 1.6-mm thick, single-side PCB

Set the pins of the DIP Switch to OFF before soldering the DIP Switch.

Before soldering the DIP Switch on a PCB, make sure that there is no unnecessary space between the DIP Switch and PCB.

Before soldering the DIP Switch on a multilayer PCB, make sure that the DIP Switch will not be deformed by the soldering heat on the pattern or land of the multilayer PCB.

Do not solder the DIP Switch more than twice including rectification soldering. An interval of five minutes is required between the first and second solderings.

Make sure that there is no flux rise on the surface of the PCB.

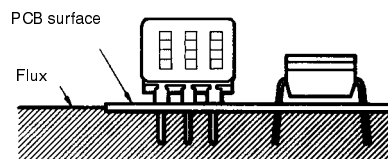

**NOTE: DIMENSIONS SHOWN ARE IN MILLIMETERS. To convert millimeters to inches divide by 25.4.**

# OMRON®

OMRON ELECTRONICS, INC.

One East Commerce Drive  
Schaumburg, IL 60173

1-800-55-OMRON

OMRON CANADA, INC.

885 Milner Avenue  
Scarborough, Ontario M1B 5V8

416-286-6465